

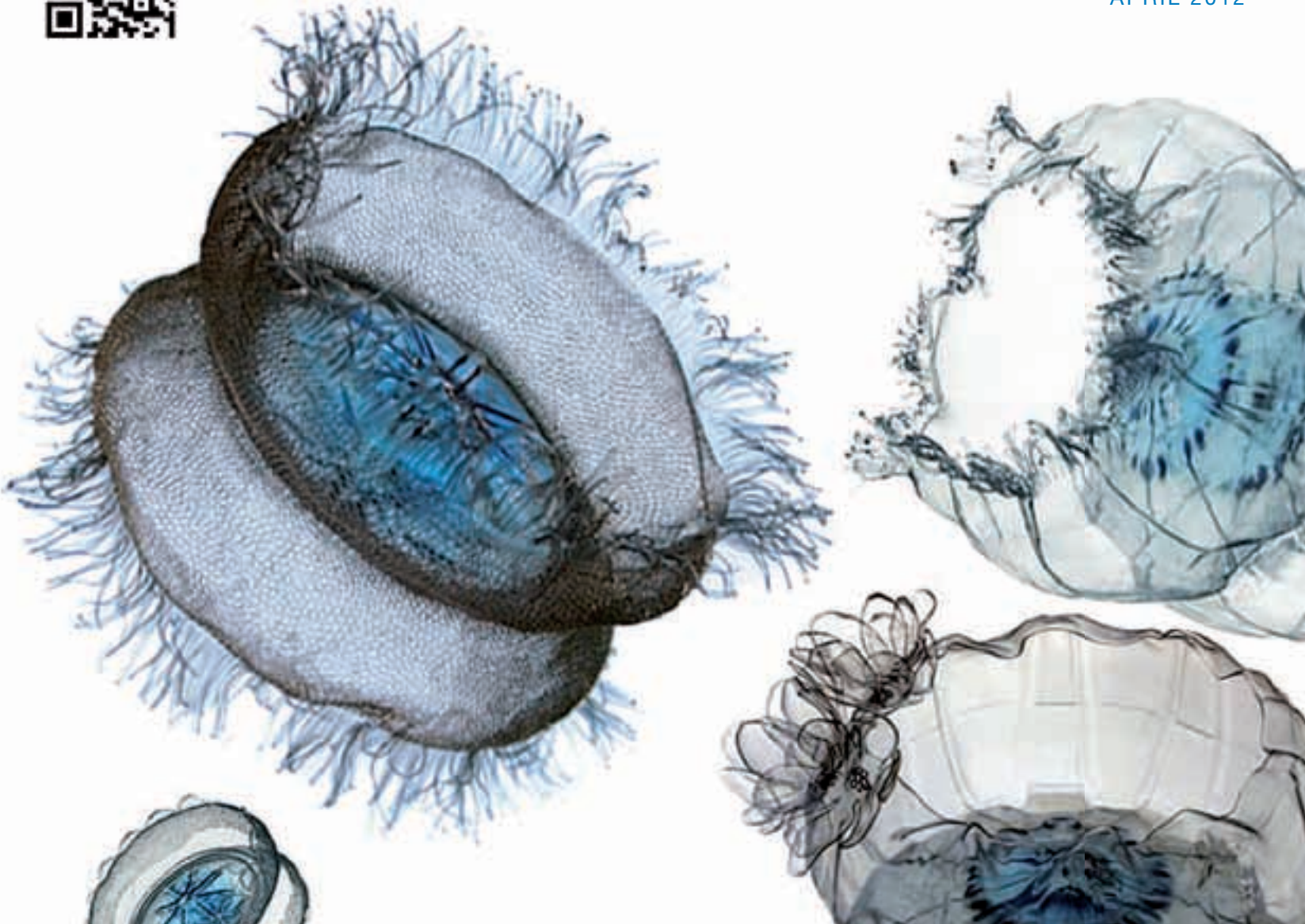

XFORM NEW PREFORM INJECTION SYSTEM

FOCUS ON

APRIL 2012



PET PACKAGING NEWS OF THE WORLD

SIPAMAGAZINE



PUBLISHED BY:

SIPA S.p.A.

via Caduti del Lavoro, 3
31029 Vittorio Veneto - Italy
+39 0438 911511
www.sipa.it

THANKS FOR CONTRIBUTIONS TO:

DevTech Holdings
Pacific Allied Product
SMI-San Miguel Industrias PET
Coca-Cola İçecek
Taba Group
Precision Plastic
The Coca Cola Company

PUBLISHED ON:
April 2012

CREDITS:
iStockphoto

Concept, Design, Layout:
Sts Italiana

COVER:
www.gulnurozdaglar.com

SUMMARY

- 5 **EDITORIAL**
THE ONLY CONSTANT IS CHANGE
- 8 **DEVTECH - USA**
BLOWING HOT AND COLD
IN NEW HAMPSHIRE
- 12 **PACIFIC ALLIED-HAWAII**
STILL WATERS RUN...
ON SIPA LINES!
- 15 **SMI-PERU**
SAN MIGUEL INDUSTRIAS
PET - A KEY PERUVIAN
PARTNER FOR SIPA
- 18 **COCA-COLA İÇECEK- TURKEY**
ULTRA-CLEAN BOTTLE FILLING WITH
COCA-COLA IN TURKEY
- 22 **TABA GROUP - EGYPT**
SIPA HELPS TABA GROW
IN EGYPT
- 26 **PRECISION PLASTIC - THAILAND**
SIPA MACHINES PROVE IDEAL FOR TOP THAI
CONVERTER'S MULTI-FORMAT OPERATION
- 29 **COCA COLA - USA**
SIPA PLAYS HOST
TO COCA-COLA
- 34 **FOCUS ON XFORM,
NEW PREFORM INJECTION
SYSTEM**
SIPA'S NEW XFORM -DESIGNED
TO ADAPT AND BUILT TO LAST.
- 42 **SFL WIDE-MOUTH**
SIPA ENTERS NEXT STAGE IN EQUIPMENT
FOR WIDE-MOUTH CONTAINERS
- 46 **ELECTRICAL STRETCH**
SIPA STRETCHES
THE BODY ELECTRIC
- 52 **DESIGN FOR IDS GROUP**
IDS GROUP UKRAINE SCORES WITH SIPA
FOR THE BIGGEST SPORT EVENT
- 55 **CAPPELLO DESIGN**
SIPA NOW MAKES
CAPPELLO DESIGN
- 57 **FAST PROTOTYPING**
PROTOTYPE MOLDS HAVE
A CELL TO THEMSELVES
- 60 **INJECTION MOLD**
A PREFORM INJECTION MOLD
FROM SIPA IS A FRIEND FOR LIFE
- 62 **JUST AROUND SIPA**
THE TRUE CHARM OF THE PROSECCO
SUPERIORE DISTRICT
- 64 **NEW SIPA N.A.**
A NEW HOME FOR SIPA
NORTH AMERICA
- 66 **NEXT EVENTS 2012**





EDITORIAL

“The only constant is change.” We’ve all heard the expression before, but it is even more valid today than when the Greek philosopher Heraclitus coined it some 2500 years ago. We all have to adapt to change, even those of us who cause change to happen. At SIPA, we look at change from all sides. We try to pick up changes in our environment and our markets, and react as quickly as we can to them. At the same time, we develop and build equipment that can itself accommodate change. And of course we like to initiate change. Not because change in itself is good, but because we don’t believe

in another well-honed expression, “If it ain’t broke, don’t fix it.” There is always a better machine, a better mold, a better preform, a better bottle, waiting to be made, and our aim is to make sure that they get made. This edition of the SIPA Magazine is full of stories about change, in one form or another. Take our new Xform preform injection molding system for example. We want to change the landscape for large-scale production of PET preforms, but we don’t expect the customer to change entire mold parks just so that we can make it happen. So we made sure that this all-new system is capable of accepting the vast majority of high-cavitation molds currently out in the field, whether they are made by SIPA or one of its main competitors. And we also made sure that the time taken to change a mold is lower than on any rival system. But that may not be a sufficient argument for making a customer to change their machine supplier. Which is why we also made sure that the TCO – Total Cost of Ownership – of the new system is easily the lowest on offer. More change in your pocket, so to speak. The world of wide-mouth jars is changing too, and SIPA is helping change it. Volumes are increasing and margins are falling. We are introducing the first total system for two-stage production of the jars, using SIPA injection molding equipment and SIPA stretch-blow molding equipment. The SFL WM system is the most cost-effective way yet - and the most versatile, thanks again to fast mold changes - of producing jars on a large scale. In our last issue, we talked about neck lightweighting. In this issue we talk about base lightweighting. More and more major brands are switching over to a new type of preform, the Cappello Design, that incorporates subtle changes to the base design that shave several percentage points off the total weight, but without processors having to make major changes to their processing equipment and parameters. SIPA is very happy to announce that it has signed an agreement with the owner of the Cappello Design that allows it to be incorporated into SIPA preform molds. SIPA wants its customers to be able to change too, in the sense that we want to give them the greatest flexibility possible, to allow their imagination to take flight. When required, we can add our engineering and design expertise to yours to create the most amazing objects. As you will see when you look through the pages of this magazine, whether it is a football-shaped bottle to help celebrate the European Football championships, or bottles that can be blown and filled up in the mountains for drinking on the beach, [SIPA is there to help bring your project to success. That, at least, is something that will not change.](#)

Enrico Gribaudo
General Manager

A handwritten signature in black ink that reads "Enrico Gribaudo". The signature is stylized and cursive.



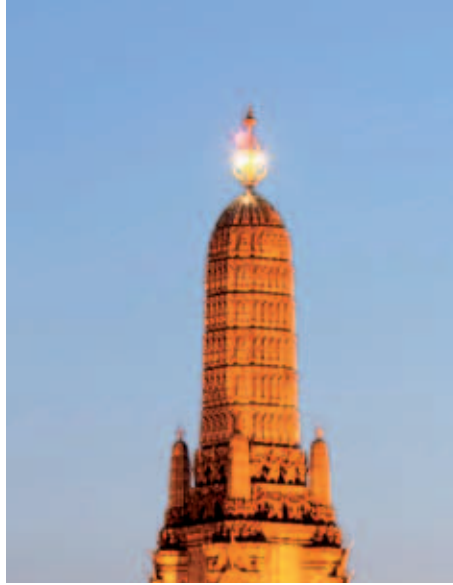
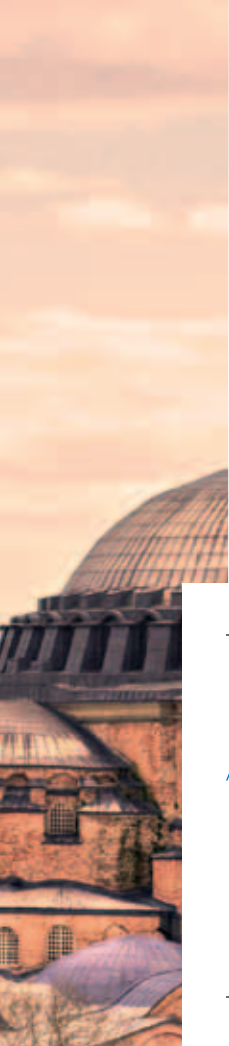

AROUND THE GLOBE:
NEWS FROM THE
DIFFERENT CONTINENTS



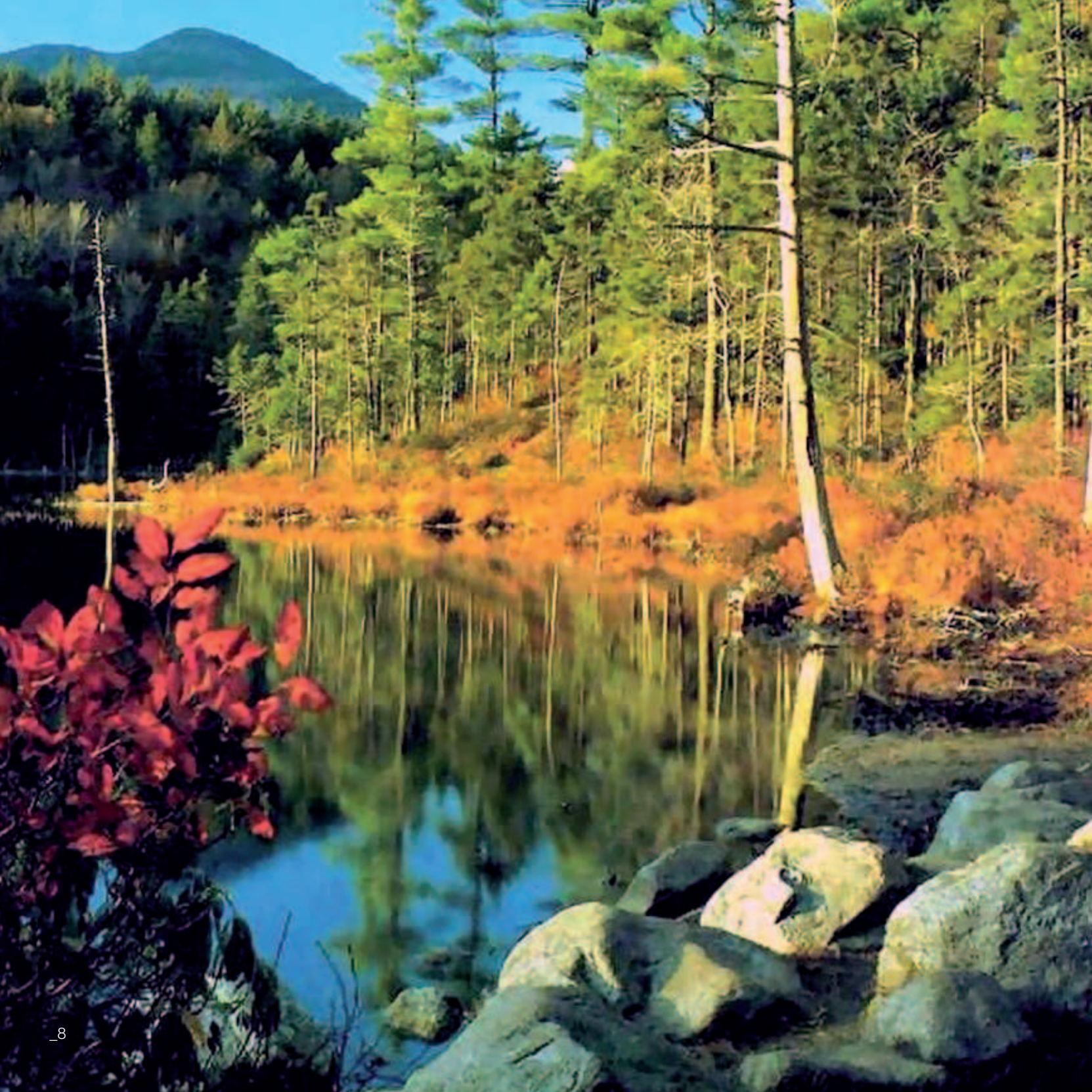

BLOWING HOT AND COLD IN NEW HAMPSHIRE



DevTech Holdings is one of the latest companies to adopt SIPA technology for production of hot-fill containers.

The company, located in Amherst, New Hampshire, in Northeastern USA, took delivery earlier this year of an SFL6/4 L linear blow molding unit for large containers. The unit came complete with two four-cavity mold sets, a hot-fill kit and air recovery system for production of multi-serve hot-fill bottles for juices. Also included in the set-up are a preform dumper and a quick change kit for the molds. Founded in 1986, DevTech has become a leader in the development of PET container technologies. It has created numerous innovative plastic preform, bottle and jar designs for the food/beverage industry. Ten

years ago, it established a manufacturing division, Preforms Plus, Inc. - PPI – to provide specialty PET preforms and containers utilizing proprietary technologies developed by DevTech Labs.

It manufactures high-end products, and also offers a complete customer service package. DevTech's business is now growing fast, and it needed a fast, reliable system for PPI to produce large format hot filled containers. So SIPA was a natural choice. DevTech has developed two

hot-fill mold sets for use on the SFL6/4 L. The first is for the production of 64-fluid ounce (approx 1.9 L) rectangular containers with 43-mm necks, weighing 72 g.

The second is for 32-fluid ounce round containers, weighing 42 g, with 38-mm necks. Respective output rates are 900 and 1000 bottles/minute.

Future plans include more hot-fill containers, as well as large-format cold-filled containers.

“The SFL6/4 offers more cavities and a faster output rate per cav-



ity than comparable machines on the market,” says Mark Galvin, East Coast Sales Manager for SIPA in North America.

“With DevTech currently evaluating larger multi-serve hot fill containers, the 195-mm blow pitch spacing is a real advantage. The linear hot fill package uses oil heating, but it is relatively easy to convert from hot fill to cold fill applications. The hot-fill kit is designed with flexibility in mind - DevTech is a cus-

tom bottle maker and flexibility is an important feature of the machine.

Mold and finish changes can be accomplished quickly.

The machine can be easily field retrofitted to add features like preferential heating for complex oval containers.”

Galvin also points out that the SFL6/4 is simple to operate.

Training and start-up is a short and easy process. “SIPA offered our experience in hot fill tech-

nology, a higher output system with more cavitation, flexibility to run non hot fill jobs and other complex shapes, rapid changeovers, after sales service and support”.

“When we started our machine evaluations we explored several blow machine platforms,” says Marty Beck, President and CEO of Preforms Plus and DevTech Labs. “We found the SIPA team very responsive to our needs and the machine a good match to our specifications.

We were very pleased to have the SIPA machine and technicians arrive at our facility and have the first bottles blown on the third day.” “We are fortunate that our business is growing rapidly as we add three- and four- liter hot-fill bottles.

We are excited about the future and expect to have SIPA play a prominent role in our growth.”



Marty Beck, President and CEO on the left and Martin T. Morrissey, Marketing Manager for Preforms Plus, Inc

SIPA





STILL WATERS RUN... ON SIPA LINES!



In Hawaii, Dasani still water drinkers quench their thirst in bottles produced and filled using SIPA equipment.

Pacific Allied Products - Hawaii's leading plastics manufacturing company based in Kapolei - installed its first SF 12/8 linear reheat blow molding machine in 2003 and followed that five years later with an SFL 6/6. Then in 2010 SIPA was called on to install a complete bottling line with the addition of complementary equipment that included an unscrambler and air conveyor from Lanfranchi, a SIPA Stillfill 20-20-6 Gravity Filling Bloc (including rinser, filler and Arol capper), an inspection system to monitor fill level, cap presence and label presence, a Domino ink jet printer and laser

coder, a PE labelling unit, a Dimac shrink wrapper, a SIPA Genius palletizer, a Robopac pallet wrapper, and a SIPA automatic CIP (Cleaning In Place) unit. Pacific Allied Products is the single source for Dasani bottled water in Hawaii. Its filling line is set up to handle four different

bottle formats - 500mL, 20oz, 1L and 1.5L.

The complete line from blowers to palletizer and pallet wrapper operates reliably at up to 13,000 bottles per hour. Pacific Allied Products also fulfills all Coca-Cola's local requirement for CSD bottles (on the same SF



AROUND THE GLOBE - HAWAII

12/8 and 6/6 units) - Dasani is of course a Coca Cola brand. Being in Hawaii makes the location of Pacific Allied Products Ltd. the furthest away from any major land mass in the world. Due to being so remotely located, it has become 100% vertically integrated in PET processing. The company has been producing PET preforms since 2003. "SIPA was able to provide Pacific Allied Products with an all-round solution from blow molder to palletizer," says Marcel van Niekerk, SIPA's West

Coast Sales Manager. "The turnkey solution was not only specified by SIPA but also fully installed and commissioned by us."

Pacific Allied Products had access to a team of service engineers capable of fine tuning the line and at the same time providing it with a professional training schedule as well as all the production assistance deemed necessary. "SIPA continues to provide support related to technical issues as well as assist with suggested maintenance and spare



parts," van Niekerk says.

The PET bottle operations at Pacific Allied Products cover 30,000 square feet, and have a total capacity of over two hundred million bottles per year.

The company specializes in small quantities for Hawaiian markets. It manufactures containers for water, carbonated beverages, juices, and more.

In addition to off-the-shelf products in standard sizes and shapes, it also creates custom designs for customers who need specific applications.



SAN MIGUEL INDUSTRIAS
PET - A KEY PERUVIAN
PARTNER FOR SIPA



San Miguel Industrias PET (SMI) is a major Peruvian converter that uses a special SIPA injection mold to produce tailor-made preforms for hot-fill PET bottles.

SIPA worked very closely with SMI in the development of both the preform and the mold.

The newly-designed 60-cavity mold has a single hot half that can be matched with three different cold halves. With one cold half, it is used to produce the hot-fill preforms for Arca. These preforms weigh 30.5 g. With different cold halves, it is also used to produce hot-fill preforms weighing 28.5 and 39 g for PepsiCo's Gatorade.

SMI also blows the Gatorade bottles using SIPA molds and SIPA

machine. SIPA and SMI have worked together for many years. SMI has a lot of SIPA blow molds (running on machines from SIPA as well as other machines) for containers up to seven liters in size, as well as some preform injection molds with up to 72 cavities.

In addition, the company has no fewer than 12 SIPA blow molding machines of its own, all but one of them rotary types.

SMI traces its roots back over almost 70 years, and is now run by the third generation of the family that founded it. The company has been involved in the PET packaging sector since 1995, and claims leadership in the production and commercialisation of PET contain-

ers in Peru. It also has production sites in Ecuador, Colombia, Panama and El Salvador. They also are large preforms exporters and do business in Central and South America as well as the Caribbean. SMI produces 2.5 billion preforms per year of which 2 billion are blown by themselves, they develop PET preforms and bottles for CSDs, water and edible oils, as well as hot-fill products such as sports drinks and fruit juices.

Recently they started a bottle to bottle recycling plant to replace 14,400 of the 84,000 tons PET resin consumed yearly.

Company owner Mario Barrios says SMI plans to further increase its presence in Latin America by providing high level customers





satisfaction's products and a personalized and efficient service. He says SMI can cater for a wide range of market requirements. "This allows us to have constant and close contact with our customers to ensure service quality and to strengthen the development of our joint activities," he says.

SOME QUESTIONS FOR MARIO BARRIOS

What were your reasons for choosing SIPA?

SIPA is a company that has shown us to have their own technology. They are also a very responsible supplier, have a personalised and good after sale service. In SMI we consider SIPA a strategic business partner.

Can you explain how SIPA has worked/works with you

as a strategic partner on lightweighting and/or development of bottles and preforms with a high technology content?

As said before, SIPA has developed its own technology, we tell them our targets in bottle design and weight reduction goals (for bottles and preforms), some of them are really hard to achieve but they have proven us to be very effective in their work.

ULTRA-CLEAN BOTTLE FILLING
WITH COCA-COLA IN TURKEY

Coca-Cola İçecek

AROUND THE GLOBE - TURKEY

CCI employs close to 9,000 people and has operations in Turkey, Pakistan, Kazakhstan, Azerbaijan, Kyrgyzstan, Turkmenistan, Jordan, Iraq and Syria as well as exports to Tajikistan.

One of the biggest Coca-Cola bottlers in the world has installed a SIPA unit for filling natural spring water bottles at the rate of up to 14,000 bottles per hour in ultra-clean conditions.

Coca-Cola İçecek is the sixth largest bottler in the Coca-Cola System, in terms of sales volume. Some 20 operations in Turkey, Pakistan, Kazakhstan, Kyrgyzstan, Azerbaijan, Turkmenistan, Jordan, Iraq and Syria, employing close to 9000 people, handle various sparkling beverages, juices, waters, sports and energy drinks, and teas.

In Köyceğiz, by a lake in southwest Turkey, the company uses a Unitronic SC electronic volumetric gravity filling monobloc



for 1.5 liter natural spring water bottles. In future, it will also fill 500ml size.

Originally installed to handle bottles with 29/25 short neck, the Unitronic SC can handle bottles with sport caps.

The monobloc incorporates not only the 35-valve filling unit, but also a rotary rinsing turret

with 35 grippers, a rotary capping turret with seven heads, and a mechanical caps elevator.

This solution is extremely clean: there is for example zero contact between the valve and the bottle, and between the bottle contents and the external environment, making it particularly suitable for ultra-clean solu-





tions. The valves are very simple, product chambers do not come into contact with a single pneumatic part, and there is a dummy bottle activation system that is extremely simple and automatic, thanks to an innovative sliding solution.

The sealing is guaranteed by a pneumatic rise of the bottle lifter. The dummy bottle has also been designed to keep the signification recovery circuit inside. Further features ensuring maximum cleanliness include a sloped stainless steel basement for all the monobloc components, including rinser and filler; a capper made in IES (inox external surface); ultraviolet lamps on the caps chute to clean the caps immediately before encapsulation; and a controlled contamination room with laminar flow to ISO 7, provided with HEPA filters.

Air recirculation, necessary to maintain dynamic overpressure conditions, is guaranteed by a filtration/ventilation module positioned on the upper part of the container room.

Each module autonomously generates a laminar flow of sterile air inside the container room

and has its own pre-filtration, absolute filtration and ventilation functions.

The limited number of components and moving parts makes the Unitronic SC very easy to clean. The sanitation phase is very simple and is fully automatic; the cycle is carried out in such a way that the cleaning solution laps all the internal areas of the filler with forced flows. The dummy bottles can be loaded automatically and safely, without the need for operator intervention.

The Unitronic SC is also very precise. Magnetic flow meters are mounted directly on the filling valves, eliminating the need for a filling tube.

This solution ensures that exactly the right amount of liquid goes into each bottle.

The investment in the Unitronic SC is integral to Coca-Cola İçecek's strategy for future growth.

The company's commitment to productivity and continuous innovation throughout its business results in not only an outstanding financial performance but also an exceptional sustainability performance.

Coca-Cola İçecek has already set out its strategy for growth through to 2020.

Hopefully, SIPA will be an important partner on its way to its ambitious objectives.





SIPA HELPS TABA GROW IN EGYPT



One of the leading producers of packaging for pharmaceutical and special applications in Egypt and the Middle East recently installed two SIPA linear stretch-blow molding machines to help it expand its business. Indeed another order for a SIPA linear stretch-blow molding machine has been just placed, which proves the excellent partnership between supplier and customer.

The Taba Group, in El-Obour City, not far from Cairo, prides itself on investing in high quality machines, moulds and quality materials, for use by a well-trained and a widely experienced team.

It added two SFL 4/4 units to its machine park in 2009, each producing between 4000 and 5000 bottles per hour. The machines make bottles for detergents – including the Dixan dish washing liquid made by Henkel





(photo) – as well as pharmaceuticals. Containers range from 125 to 1250 mL in size.

“SIPA is a well-known and reputable name in the field of stretch blowing machines,” says Mr. Ahmed Shalaby General Manager at Taba. **“SIPA delivers high machine standards backed up by strong customer relations.”**

According to SIPA’s Sales Area Manager, Taba was particularly impressed by the user-friendly touch screens on the SFL machines, which facilitate the process of setting up recipes and making process adjustments for particular bottles.

Taba also appreciated how consistent the bottle quality is, with variations being uncommon and negligible.”

Also important for Taba, which produces bottles in numerous shapes and sizes, is the relatively quick and easy mold change process, while the alarm system in the machine software makes locating the source of a problem straightforward, as is remedying the problem.

“SIPA has one of the most effective and efficient customer service and technical support” says Mr Mohamed El Debaiky, at Taba **“Spare parts are always available and delivered quickly and whenever tech-**

nical support is needed, SIPA gives good support by e-mail or phone and send a qualified technician straight away when needed”.

According to Taba’s Management, Sipa is acting more as a “solution provider” rather than a traditional and ordinary machinery supplier, which in today’s world makes a great deal of difference.



SIPA MACHINES PROVE IDEAL
FOR TOP THAI CONVERTER'S
MULTI-FORMAT OPERATION





Some 250 kilometers west of Bangkok, Precision Plastic Co., Ltd. has been pioneering the development of hot-fill PET beverage bottles for the Thai market for over eight years. Since 2003, thanks in large part to the success of key customer OISHI, a well-known Japanese producer of green tea beverages, the company has made a string of investments in blowing and filling equipment for a wide range of containers, many of them hot-fill types. Since it was founded in Nakhon Sawan province in 1996, Precision Plastic has developed into Thailand's largest bottle converter. It first focused on HDPE containers for drinking water, but since the turn of the century has moved its attention to PET packaging, gaining a reputation with beverage makers for its

use of new technologies to best meet market needs.

A PARTNERSHIP WITH STRONG VALUE

SIPA has been working with Precision Plastic for five years now, and together the companies have developed numerous highly attractive bottle designs for production on SIPA stretch-blow molding machines with SIPA molds. SFL linear machines in particular are perfectly suited to Precision Plastic's business, which entails quite frequent format changes – this is something that can be done quickly and easily on such units. In fact, Precision Plastic was an early customer in 2007 for the latest SFL model capable of producing the full gamut of PET bottle types – hot-fill bottles with pan-

els and without panels, CSD and mineral water bottles. Not only is it very easy to perform changeovers on the SFL – less than 20 minutes to change molds, and a similar amount of time to change neck sections – but the machine’s mold back plates will accept non-SIPA mold shells as well, making it especially versatile. Two years later, Precision Plastic took delivery of another two SFL units.

Then in 2010, Precision Plastic was one of the first companies to take advantage of SIPA’s innovative SFR16 EVO rotary stretch-blow molding machine. This too can produce hot-fill bottles, CSD bottles and water bottles, at rates of up to 2000 bottles per hour.

ELECTRICAL HEATING FOR HOT FILL BOTTLE PRODUCTION

Unlike other rotary machines, the SFR heats the molds with electricity, not oil. The system is more energy efficient (heat is only applied where it is needed, and start-up times are shorter), it is cleaner, has a lower maintenance requirement (no need to change gaskets, for example), more versatile – each mold has its own temperature control – and more user friendly. Mold changes require only the shell to be changed, not the entire mold. Furthermore, electrical heating is safer, with no chance of operators coming into contact with hot oil.

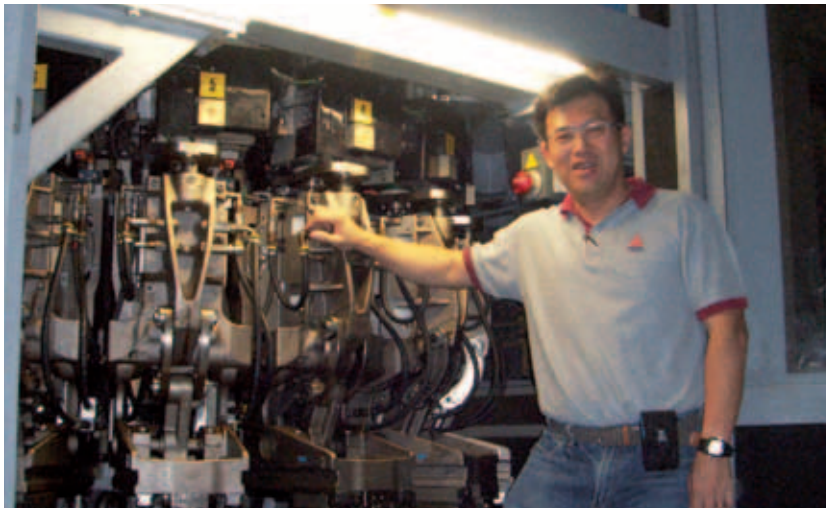

THAILAND'S FLOOD 2011

SIPA IS CLOSE TO ITS THAI CUSTOMERS WHO HAVE SUFFERED FLOOD CRISIS IN THE LAST MONTHS OF 2011.

*Mr K.Somsak, Precision
Plastics Owner.*

SIPA PLAYS HOST
TO COCA-COLA

The Coca-Cola Company



As several articles in this magazine testify, the Coca-Cola Company, the owner of one of the most famous and popular brand names in the world that last year celebrated its 125th anniversary, is also a very important and long-standing SIPA customer. The relationship between the two companies has developed substantially in recent years, yielding significant results around the world, especially in Latin America, the Middle East and Asia.

At the end of February, SIPA had the pleasure of welcoming a delegation from The Coca-Cola Company in Atlanta to its operations in Vittorio Veneto. The delegation spent a full day touring the facility and discussing business developments, areas of cooperation and new opportunities with SIPA managers. Several projects are currently

ongoing: they include the supply of complete bottling lines, but most of them are focused on new packaging development.

The visit enabled the drinks company executives to see SIPA's activities dedicated to packaging development, and they were also provided with a detailed view of the mold shop. Rotary blow molding equipment and SIPA's new high-output preform injection molding system (see elsewhere in this publication) were also a focus of attention.

We asked some questions to Tim Fordree, Coca-Cola's Director, Capital Equipment Procurement.

This is not the first time you have visited SIPA's headquarters.

What are your impressions of the company and what you think has changed from the previous visit?

My previous visit in 2009 was under the premise of bottled water package development and lightweighting. Today, my role is one of production equipment.

The benefit for Coca-Cola is that Sipa can be seen today as a strong supplier in both roles – Packaging Development and Production Equipment.

In the wake of your visit, do you consider SIPA as a company that can provide innovative input into Coca Cola Company projects?

Innovation is a critical plank in our supplier selection and development process. The growth that Sipa



has enjoyed over the last three years with Coca-Cola is a testament to the investment of Sipa in all areas of the business from R&D through Global Account Management.

Which areas of opportunity do you see between SIPA and TCCC?

We recognize that Sipa can play a strategic role in our package and equipment business around the world. This coupled with the business alignment, focus and dedication to Coca-Cola are seen as a strength which we can build on.

How would you describe Coca-Cola's relationship with SIPA and its personnel? Do you regard them as collaborative and competent?

SIPA has a renewed focus on the relationship and growing the business with Coca-Cola. Performance is improving across the board.

Our view is for Sipa to focus on core strengths such as packaging design and development, injection and blow molding and be a superior supplier in these categories.

This will open the door for further joint initiative development.



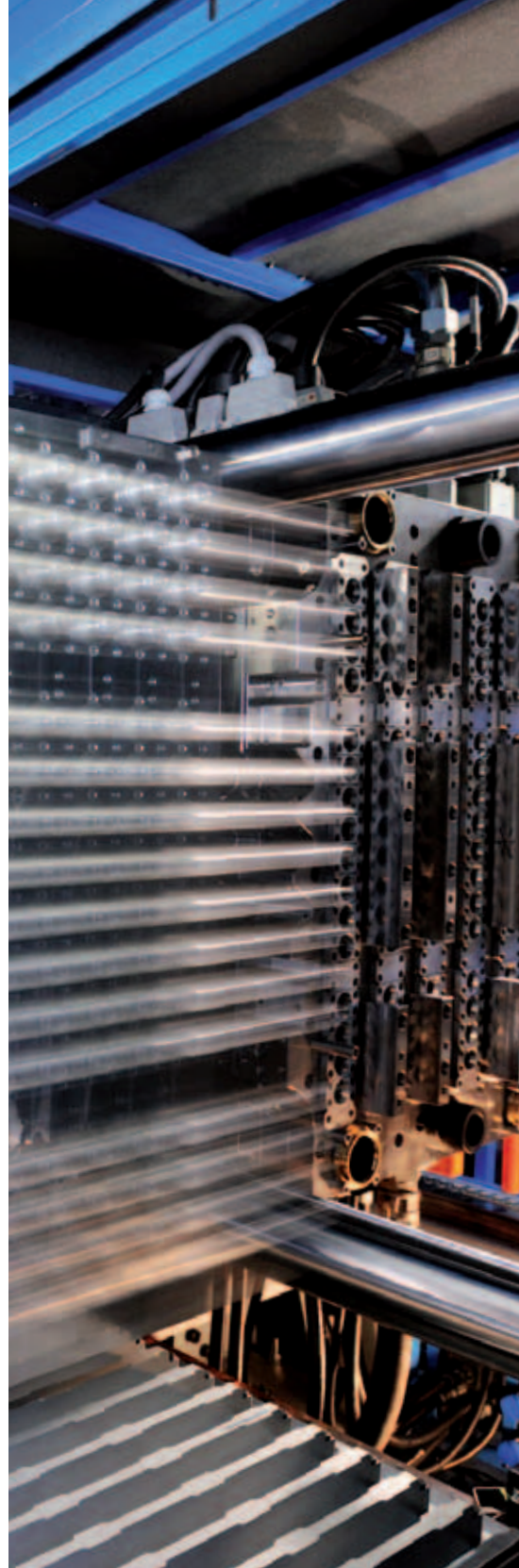

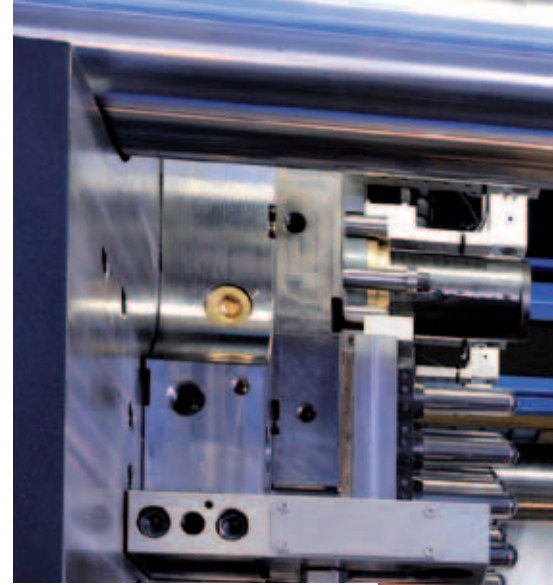

FOCUS ON
XFORM, NEW PREFORM
INJECTION SYSTEM

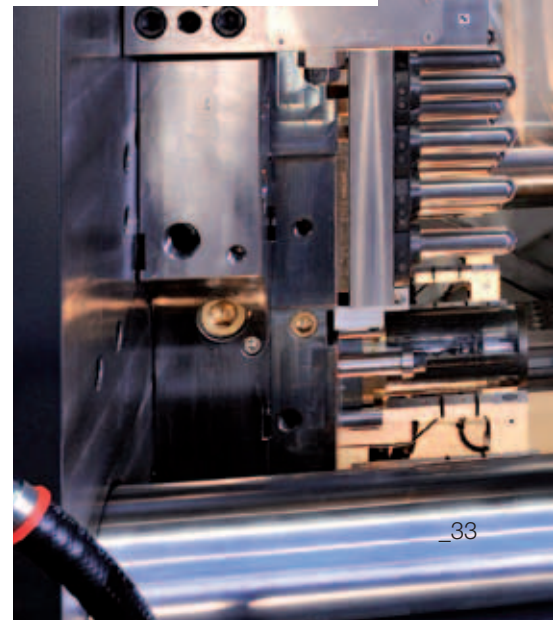

SIPA'S NEW **XFORM**: DESIGNED
TO ADAPT AND BUILT TO LAST.



You might expect SIPA's new PET preform system to deliver high output, efficiency, and a lower cost of ownership.

But the new XFORM also gives PET bottle producers **an advantage they've never had: the flexibility to use any preform mold in one long-lasting machine.** In an industry with ever-changing regulations and market demands, this freedom to adapt will yield considerable savings and opportunities to innovate.

"Our customers need more than incremental improvements to help them grow with the changes in their industry," notes SIPA General Manager Enrico Gribaudo. "The XFORM is one example of how we're thinking ahead about what makes a big investment worthwhile for them. We want them to know **we can open up possibilities for them** in addition to increasing output and efficiencies." PET bottles and preforms producers will get their first glimpse of the XFORM at NPE 2012 (April 1-5, Orlando, Florida). The 500-tonne high speed machine will feature up to 128 mold cavities, complementing SIPA's existing preform injection line. Like every SIPA prod-

uct, the robust, versatile system was designed with producers' top investment **priorities** in mind:

- **Economics** - investment costs, energy consumption, maintenance, depreciation.
- **Performance** - efficiency, productivity, consistency.
- **Process advantages** - the overall quality of the preforms, acetaldehyde levels, capability for lightweighting.
- **Environmental benefits** - the ability to efficiently use high levels of recycle and reduce scrap.
- **Operational efficiency** - ease of use and maintenance.

LONG LIFE, LOW MAINTENANCE

The XFORM's horizontal toggle clamping unit with leak-proof lubrication is just one feature that gives it a very solid, compact construction. Highly even force distribution and extremely low platen deformation result in low maintenance needs and **only minimal mold wear.** Meanwhile, the "Autoprotect" system compares closing forces on a shot-to-shot basis with a sensitivity of 1 kN (one thousandth of a tonne force) to ensure safe closing.

XFORM

WHAT'S IN THE NAME

Our new XFORM offers customers a highly desirable combination of flexibility, durability and performance that no other systems on the market can match. The components of the name hint at versatility and strength as well as what the machine does:

**"X" = any number,
no limit, infinite
possibilities, flexibility,
crossing boundaries**

**"FORM" = preform,
performance, shape,
create, produce, customise**

SIPA's well-known **low-maintenance preform tooling** also keeps the XFORM running strong. The patented air blowing system prevents dust in the hot runners, which helps raise the maintenance interval on the **hot side to five million cycles.** On the **cold side**, the molds can

easily complete **eight million cycles** before returning to SIPA for attention.

LOWER COSTS, START TO FINISH

The XFORM's total cost of ownership (TCO) is **the lowest of any machine in its class**. Since it accepts molds from any leading preform mold maker, initial

costs are especially low for preform producers who have already invested in preform molds. Producers can install a SIPA system alongside existing lines without a major investment in new tooling. Low maintenance, high efficiency, and strong competence in preform lightweighting keep running costs low. Additionally, producers can consult SIPA ex-

perts for advice and solutions at any stage of the PET production process to keep costs down and productivity high.

THE FAST TRACK

The XFORM is designed to run fast, day in and day out. With a dry cycle time of 1.6 seconds or better on a 400-mm stroke, and lock-to-lock time of around 2.6 seconds, it can run quicker than some of its major competitors-and still stand strong. Cycle time for production of 11.8g preforms with 2-mm walls and a 30/25-mm Novemba Light neck clocks in at just 5.9 seconds.

A heavier preform, weighing, say, 26 g with 2.5-mm walls and a 26.7 mm Alaska neck finish, takes only three seconds more.

EFFICIENCY BY DESIGN

Even when the machine is not running, it helps customers save time. For instance, mold change-over, preform-to-preform time, takes less than three hours.

This efficiency is built in, as large tiebar distances of more than one meter allow **easy access to the mold area**. Smart engineering also allows producers to change



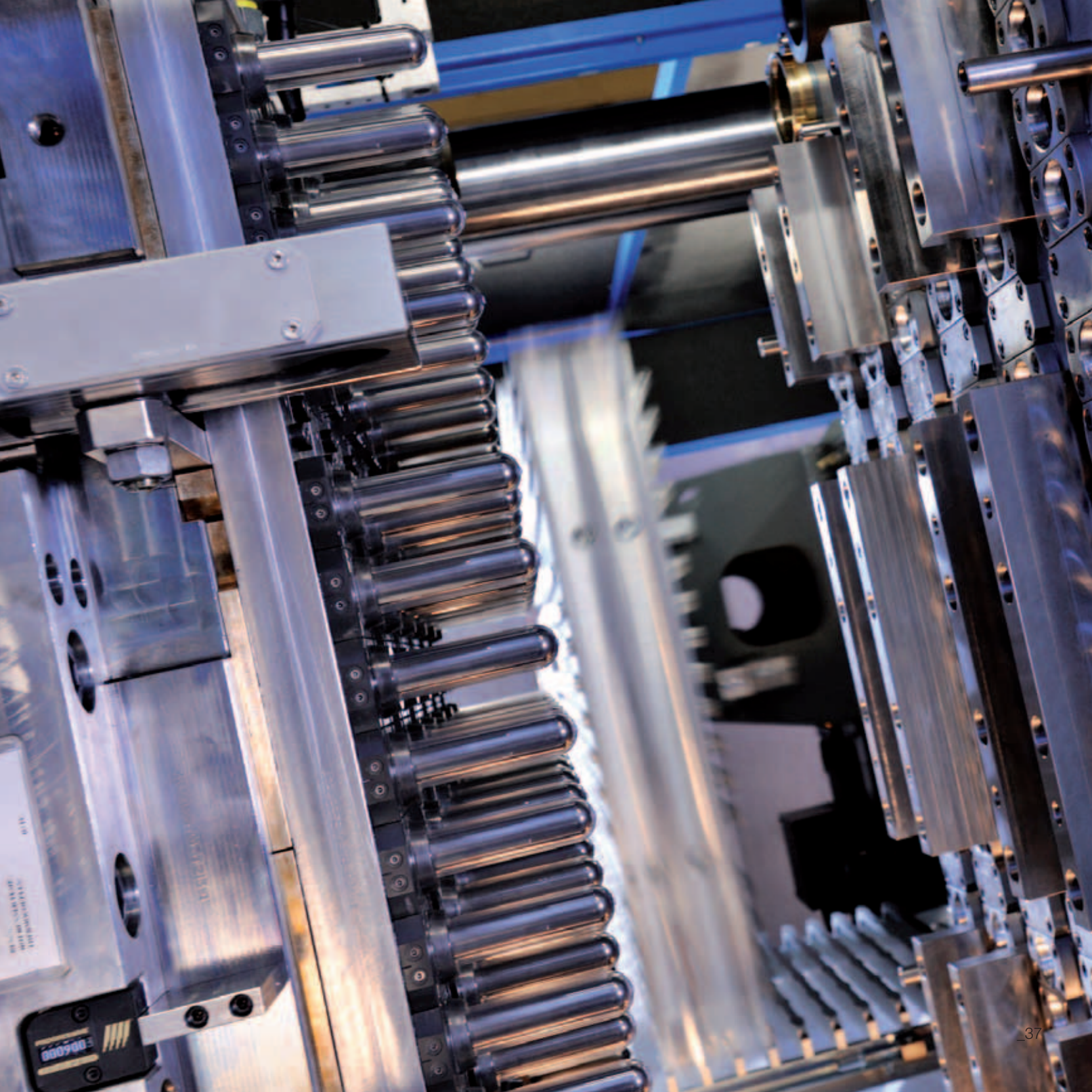

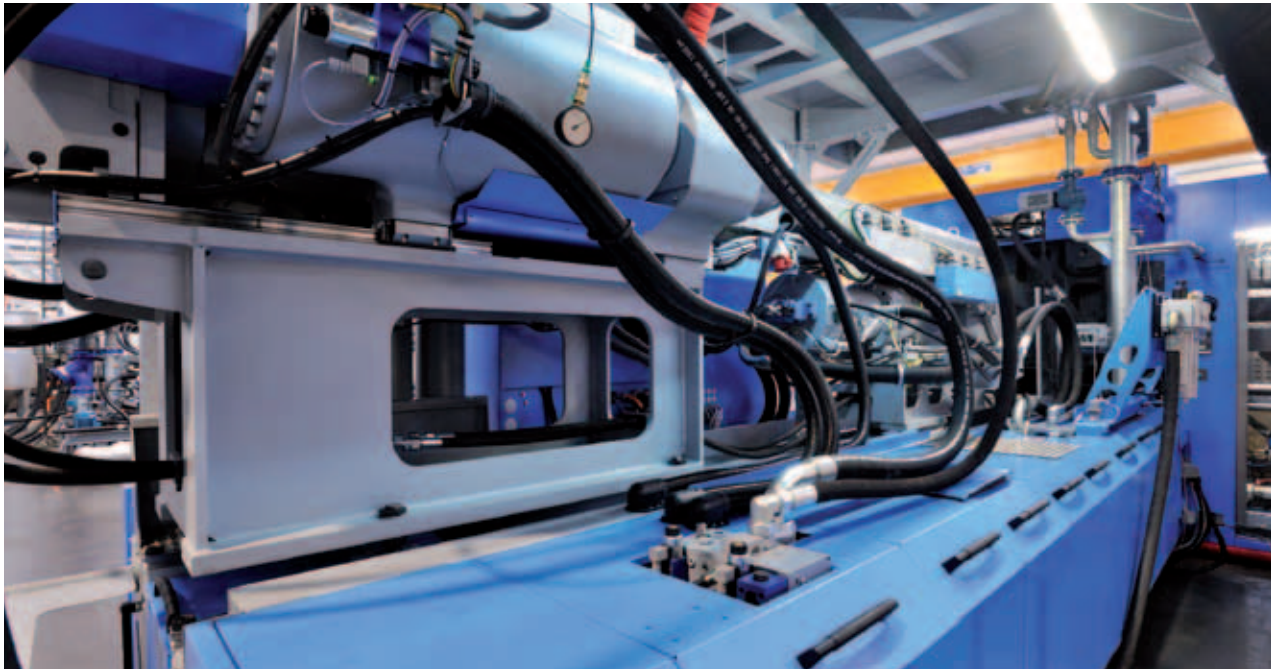

the cooling system **in less than half an hour.** Configuration changes to the preform post-molding cooling robot system are relatively simple thanks to a SIPA-patented, two-sided, single-stage system, which holds the preforms for six cycles.

The robot itself is very fast, strong, and stable; its top speed of 4.6 m/s is on par with best-in-class performance. Efficiency is the hallmark of the XFORM's plasticating and injection system. Its classical continuously-run-

ning 140-mm extruder feeds a 6-kg shooting pot and provides a high output of 1,200 kg/h at low speed. The extruder design also **reduces material stress and AA** since it needs no static mixer.

On the environmental side, the system can handle **up to 50% PET regrind (flakes)** without the need for special screws.

FREEDOM TO IMAGINE

"With our new XFORM, we offer customers a new level of confidence as they face the uncertain-

ties and challenges of the future," says SIPA's Enrico Gribaudo.

"Now they can produce more preforms faster, and for a low total cost of ownership. Perhaps most importantly, XFORM gives them the freedom to handle any mold requirement they can imagine."

SIPA's XFORM debuts at NPE 2012, April 1-5, Orlando, Florida, Orange County Convention Center, West Hall, Level 2, Booth 7963.

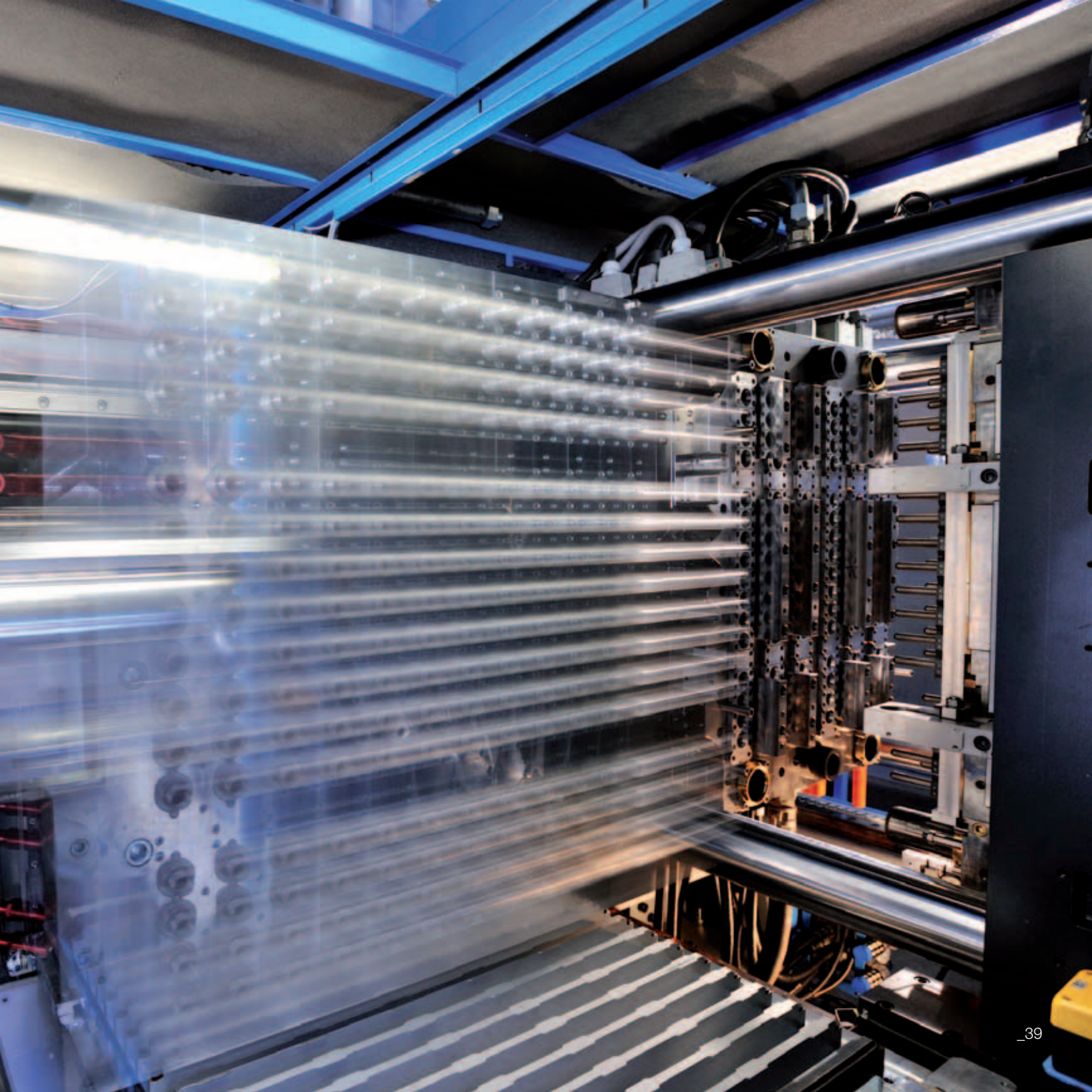

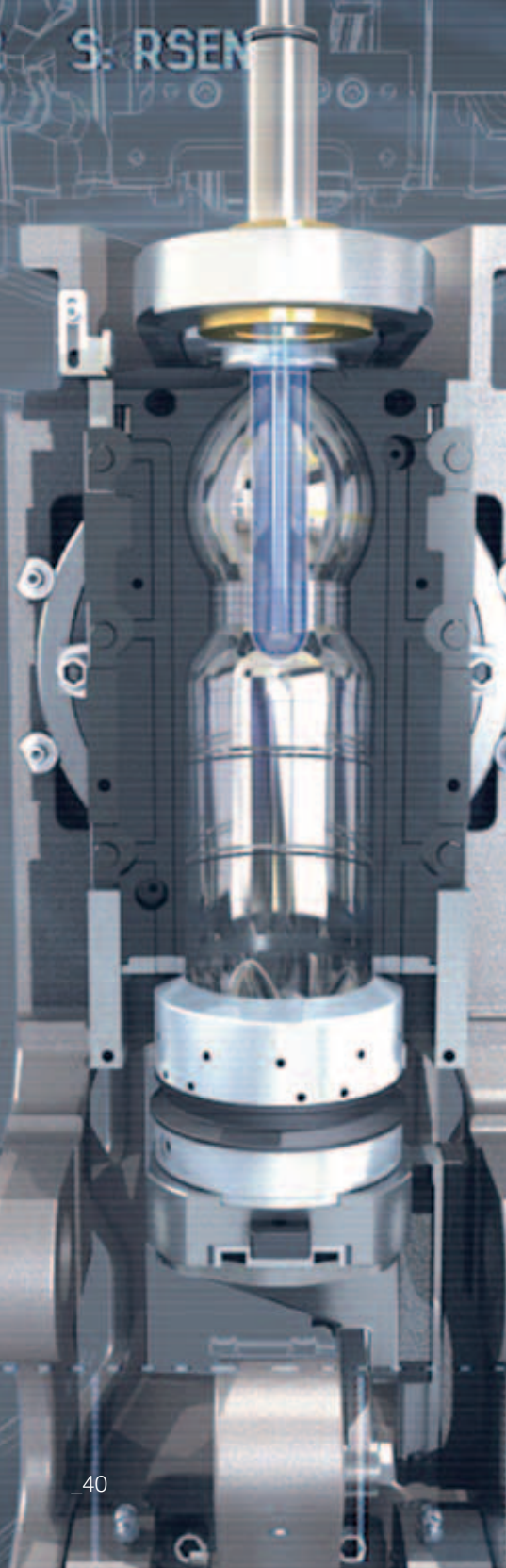



TECHNICAL WINDOW
ON SIPA PRODUCT PORTFOLIO:
LATEST DEVELOPMENTS

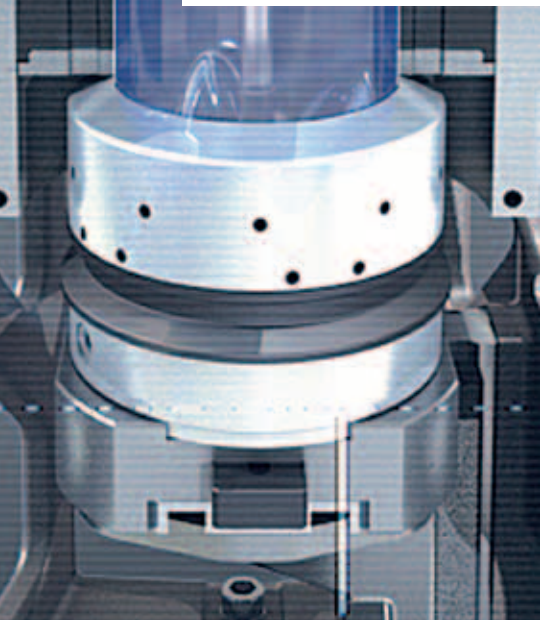

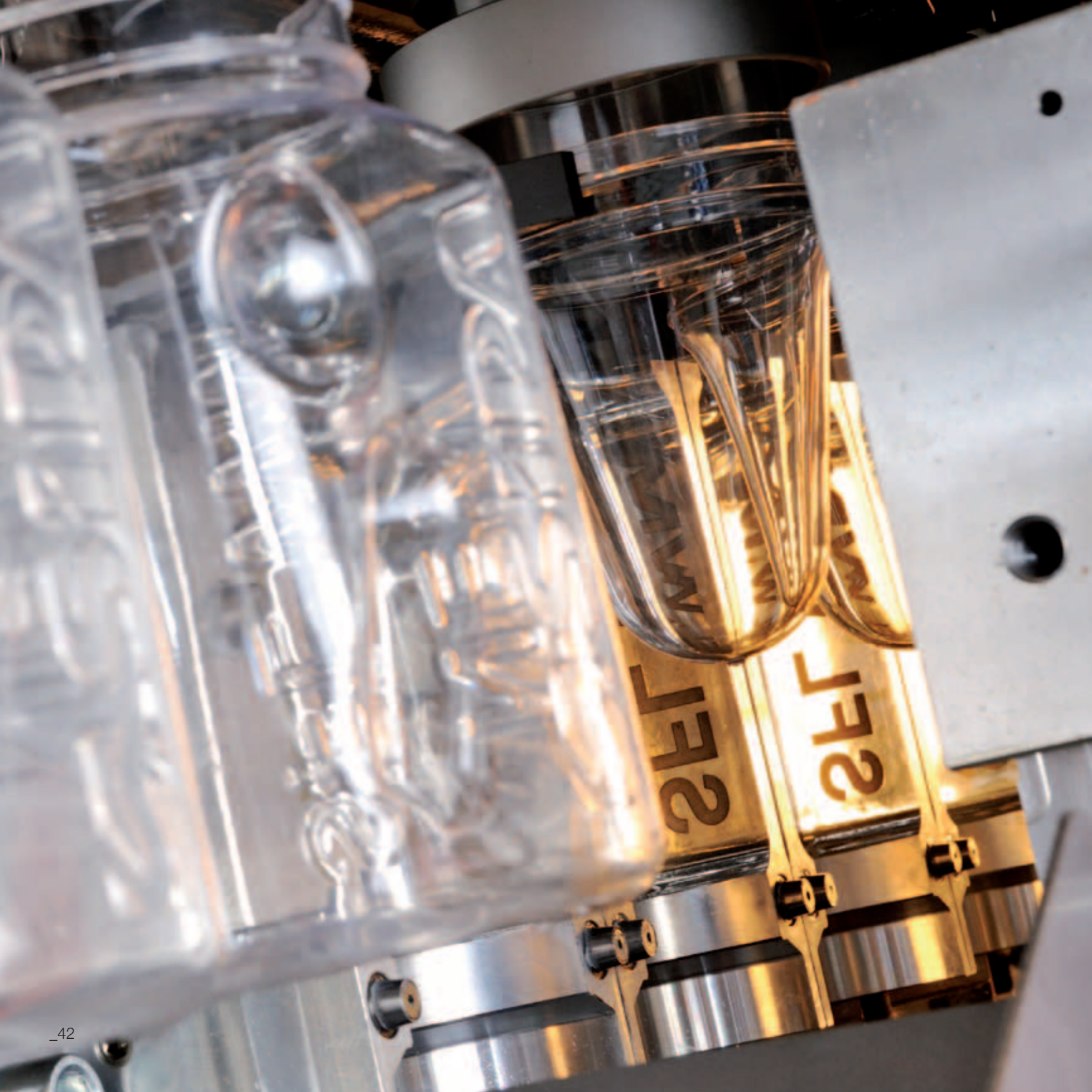

SIPA ENTERS NEXT STAGE IN EQUIPMENT FOR WIDE-MOUTH CONTAINERS

When specialty products turn into commodities, one thing can be taken for granted - prices come down. If producers of those products want to keep their margins, they have to innovate. Higher productivity, shorter response times to changing customer demands, increased flexibility.

It's happening now in wide-mouth PET jars, until now produced mostly on single-stage machines. Fortunately, SIPA has all the answers: a brand new two-stage SFL linear blowmolder to complement its single-stage technology.

SIPA is already the leading force in single-stage equipment for wide-mouth jars, with equipment distinguished by high output rates (up to 15,000 jars/hour), thanks to higher than average cavitation. In order to

go further, the company decided to extend flexibility on wide mouth platforms. Which is why the company has made the decision to apply its SFL linear blow molding - already highly successful in narrow-neck bottles - to wide-mouth designs. At NPE, it is introducing the SFL WM.

Single-stage machines do not possess the optimum flexibility necessary when a processor needs to make frequent format changes while supplying Just In Time.

The amount of time taken to fine tune the various elements of the equipment is significant, and time is money. Changeover times on SIPA SFL reheat stretch-blow molding machines are much shorter. Molds and preform carriers can be changed in around 40 minutes instead of 5/6

time more single-stage changeover time. And then there is the output. Competitor's best single-stage machines offer around 250 containers per cavity per hour. Many models have no more than eight cavities. You do the math! Compare that with a reheat unit, which produces 1,500 containers per cavity. So one SFL machine can do the work of several single-stage machines, saving on space, energy, auxiliaries, maintenance, labor - and costs.

Of course, some production of wide-mouth containers is already being done with two-stage equipment, but it is not very widespread and the economics have not always been optimized. SIPA is offering not only a new machine model but a new business model.

At the moment, the small number

of producers of wide-mouth jars using two-stage technology in North America and Europe are heavily reliant on imported preforms.

SIPA on the other hand is offering a total production solution, a pellet-to-pallet concept, since it is expert in technologies for injection molding preforms as well as blowing them. SIPA also offers assistance in development of the ideal preform for a specific container design.

This service is available even for companies producing preforms on non-SIPA machines, so injection molders with equipment not currently running at full capacity now have new market opportunities.

SIPA is employing its benchmark SFL technology, together with important new innovations, in its new equipment for wide-mouth containers. The SFL WM is available in two configurations:

- the first is designed with speed most in mind. It can make containers with neck diameters up to 95 mm, and capacities up to three liters. Output rate of up to 6,000 containers per hour makes the machine ideal for converters with dedicated customers or applications;
- the second version is intended for customers likely to be changing

configurations more frequently.

It holds up to four cavities and can make containers up to ten liters, with necks of up to 130 mm.

Format change is especially quick and efficient.

SIPA believes there is still enormous potential for PET packaging, particularly when you take its sustainability into consideration – something that the man and woman on the street are doing more and more: production of PET containers causes far fewer greenhouse gas emissions and energy consumption compared to glass or aluminum.

If you compare it with glass, PET offers a substantial weight reduction, with energy savings that minimize the carbon footprint, also reducing the transport costs.

On top, the hazard of breakages is removed from the supply chain and, in comparison with other polymers, PET is recyclable.

Overall, the 2-stage production path can match the demands of JIT supply to the customer.

In 2010, of the estimated 1.5 trillion units of food packaging produced around the world in all materials – plastics, carton, metal and glass – just 1.5% of them were in PET. The vast majority of those

were in narrow-neck bottles.

SIPA reckons the time has come for two-stage technology in wide-mouth containers to make further market breakthroughs.

And with the SFL WM system, it has the means to make it happen.





G: MKWY

R: AQ2842

S: RSEN

0004

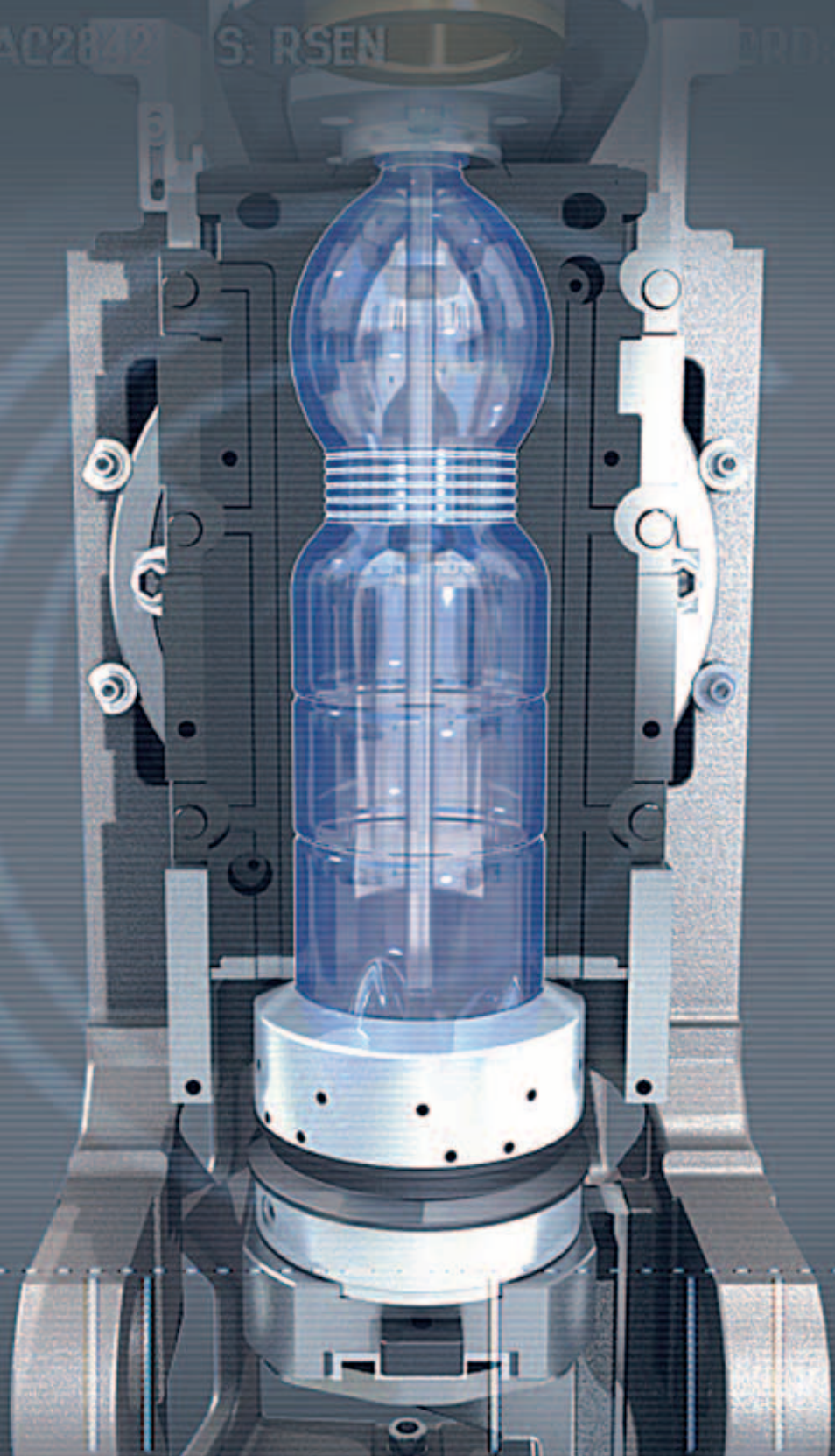

SIPA STRETCHES THE BODY ELECTRIC

It used to be that stretch rods on stretch-blow molding machines were always pneumatically driven, actuated by a cam. But this system, with its direct mechanical linkages to other machine movements, is not flexible. That's why SIPA SFR rotary blow molding machines now use servo electric motors to drive their stretch rods.

It really is no surprise, given the advantages. Breaking the link between other machine movements and the stretch rods introduces unprecedented versatility in **fine-tuning** the process and in adjusting machine settings according to container formats. Today's requirement for extreme PET bottle light-weighting is pushing the stretch-blow moulding process to its limits,

particularly when it comes to stretch ratios.

There is an urgent need for technology developments that widen the process window. SIPA's latest innovation provides a giant step in this direction.

Having said that, SIPA is actually going over territory that it is already very familiar with.

The company's linear blow moulding machines have used electric drives for their stretch rods since 2005.

But now it is applying the concept to its rotary machines for the first time.

In the past, if you wanted to change the speed at which the stretch rod moved for any given speed of the blowing wheel, you had to change some cams - something that necessarily required a



downtime of at least an hour, possibly as much as two. Various other elements in the stretching process were also laborious or impossible to adjust.

No longer. With the stretch rod now being driven by a brushless servo motor connected to the control system over a DC bus, any changes to timing, speed, acceleration and distance travelled by each rod can be controlled with ease and **flexibility** from the control panel, without having any effect on the output rate.

What this means in practice is that, for example, a production operation with inline blowing and filling can quickly switch from small containers (e.g. 0.5L) to large containers (e.g. 3 L) - which necessitates a reduction in the speed of the filling unit - without stopping the line and making mechanical adjustments. Eliminating the cam system also reduces possible sources of wear, and so extends maintenance in-

tervals. Furthermore, the machine has a '**smart self-learning function**' that comes into use when a new preform format is introduced: at changeover, the stretch rod first descends slowly to measure the length it needs to travel (preform and bottle length), and this distance is then stored and used for all subsequent cycles.

Energy saving features further add to the attraction of the new system. The DC bus is able to capture the braking energy of each stretch rod as it slows down on the upstroke (to compensate for the force of the air on the rod section) and make that energy available to the other servo motors as well as diverse electrical components on the machine. In case of power-loss, machine has a special emergency system which rises immediately the stretch rods, avoiding any problem, damage or preform issue. Last but not least, the rods can be made to rise immediately af-

ter they have finished stretching the preform, completely freeing up the neck section and allowing ample degassing.

This helps to further broaden the processing window and can in some cases lead to an increase in productivity.

Other interesting advantage is the **reduction in change-over time**: whenever you replace a blow mold set, with mechanical systems you have to replace also the stretch-rod stoppers.

Given the new electric system, with the self-learning procedure, you forget about the stretch-rod stopper as well as the ascending cam adjustment: you may save up to 15 minutes per every mold set change-over !

**Smart, flex, quick:
that's the life we want !**



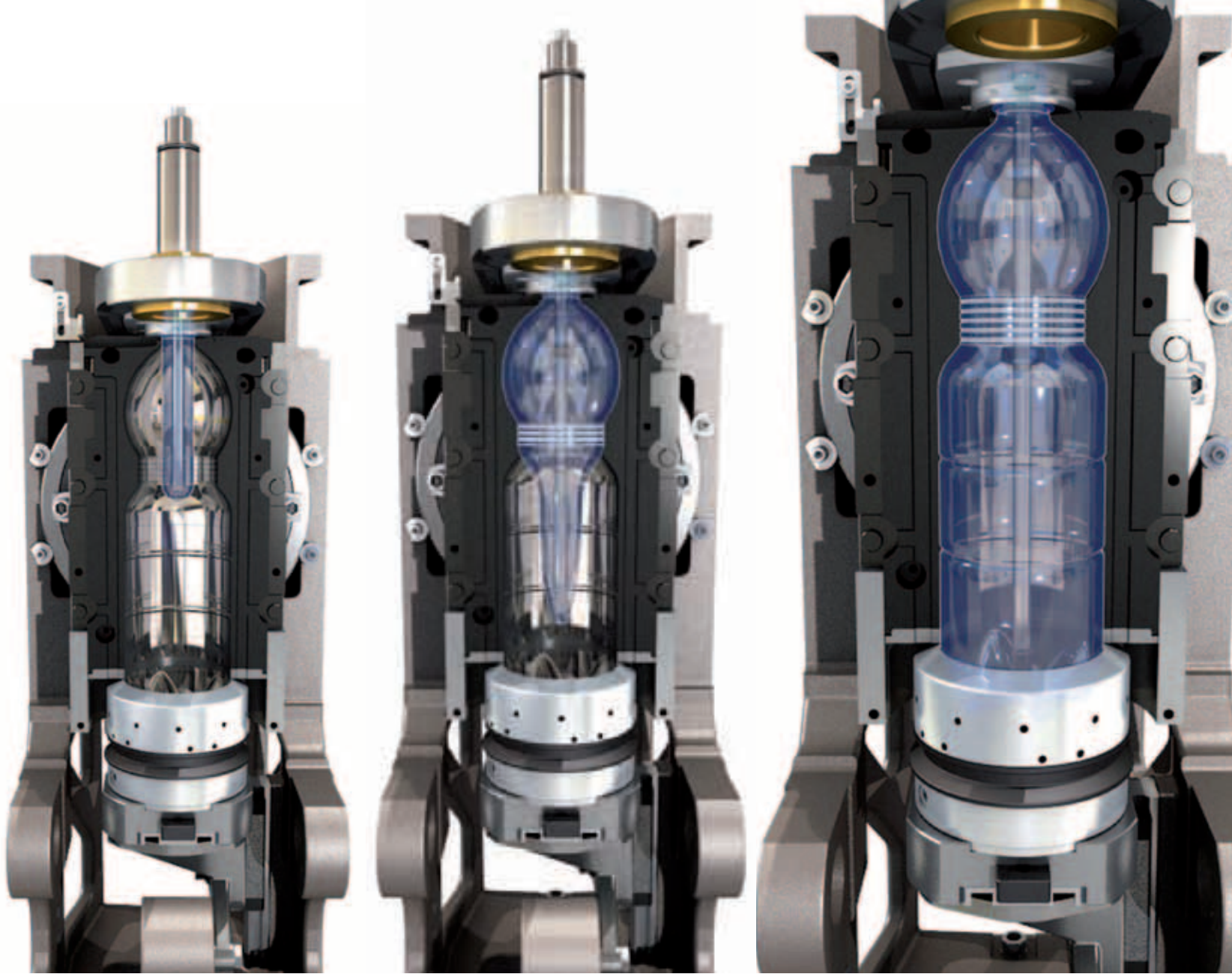

ERD/AM 01/18/24

SIPA

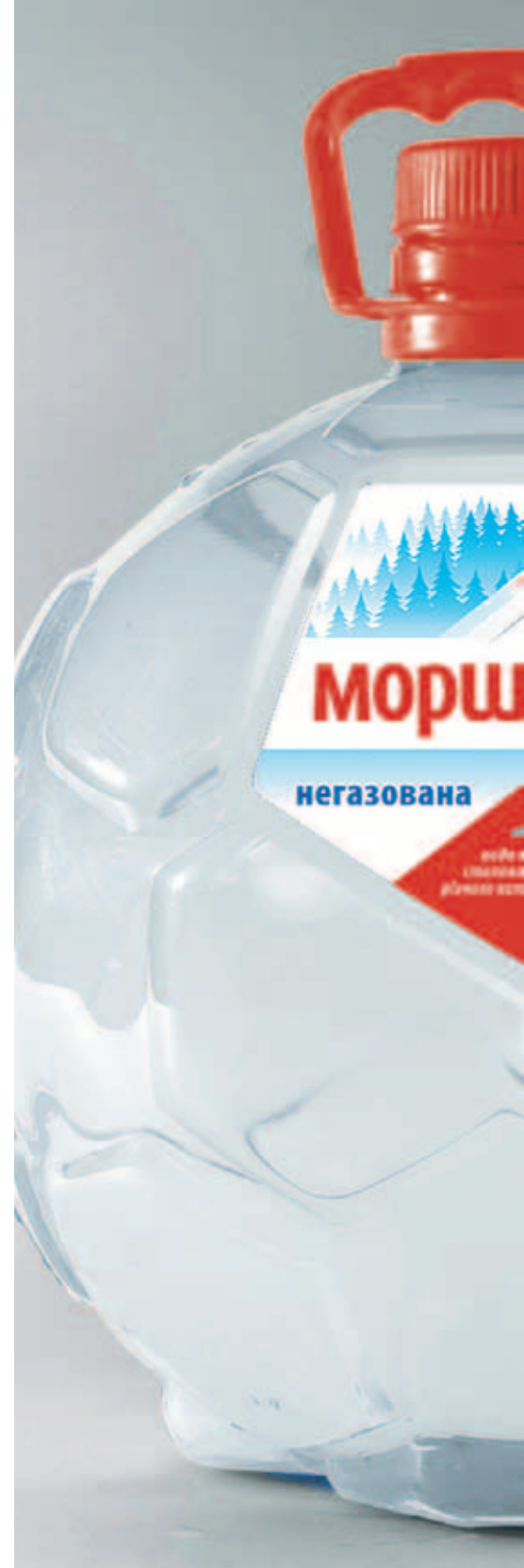
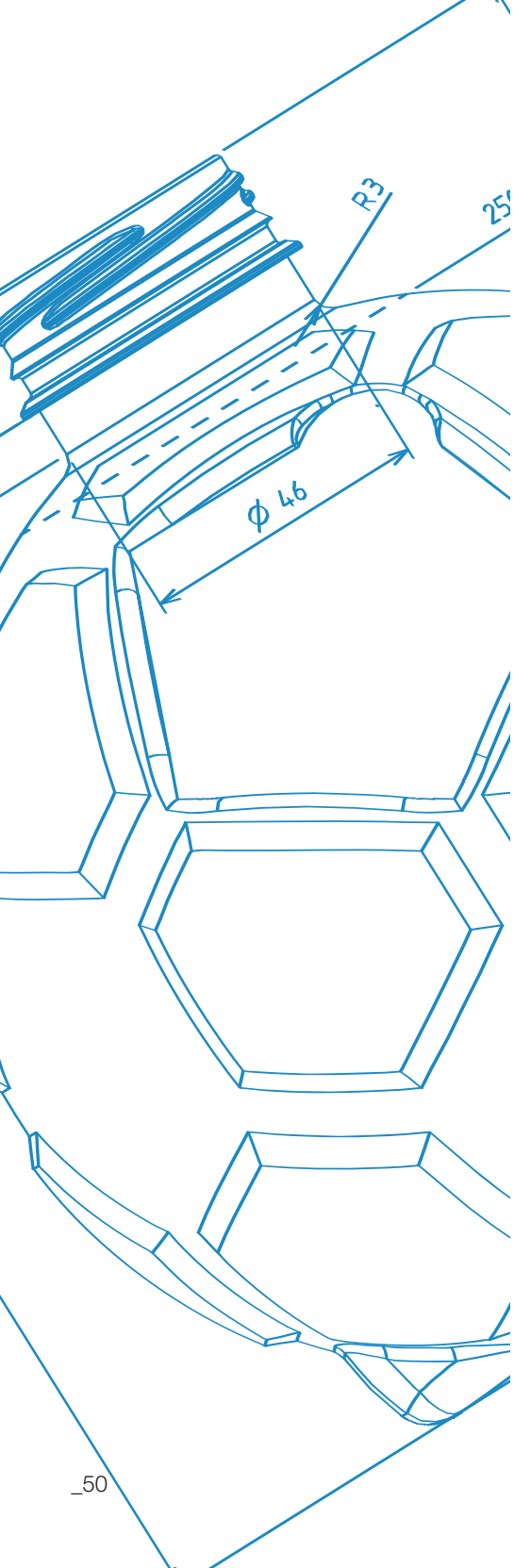



PETWORK: CONCEPT,
DESIGN, ENGINEERING.
WHAT'S NEW IN
PACKAGING WORLD

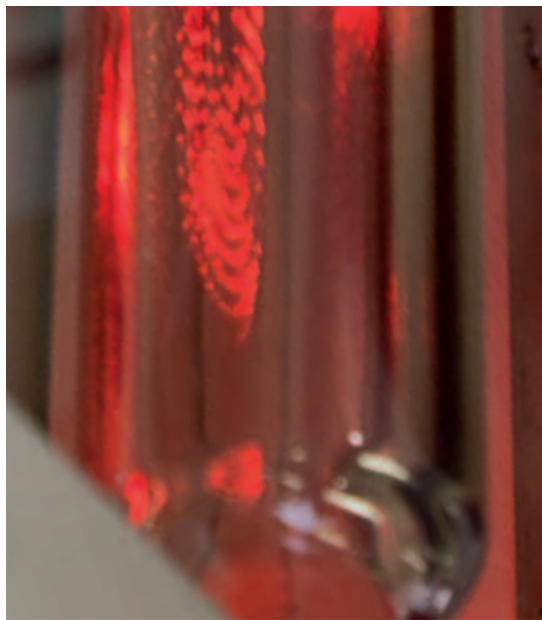

IDS GROUP UKRAINE SCORES WITH SIPA FOR THE BIGGEST SPORT EVENT



This June, European football addicts are heading East.

The 2012 UEFA European Football Championship is taking place in Poland and Ukraine.

We know that when people go to special occasions, they want something to remember them by. In Ukraine, fans won't have to go to any expensive gift shops for their souvenirs. Ball-shaped Morshinska bottles from IDS Group Ukraine are all they'll need.

IDS Group Ukraine is a part of IDS Borjomi International - the largest independent producer and one of the three largest producers overall of natural mineral water across the CIS and the Baltic countries.

It is Ukraine's top mineral water producer, and its Morshinska

brand is the league leader, so to speak. Natural water Morshinska is bottled at "Oskar" plant in the west of the country, and it does it using bottles made on SIPA equipment.

SIPA has been doing business with the IDS Group Ukraine since 2005, when it supplied the company with two lines for production of large bottles. One is in the Oskar plant, and another is in the Mirgrodska plant in the world famous health resort of Mirgorod in central Ukraine.

IDS Group Ukraine designed a limited-edition 2.5-liter water bottle in the shape of a ball to greet Morshinska fans with the biggest sport event in Ukraine. It turned to SIPA to realize the project. The bottles are made on an SFL linear blow molding

unit equipped with three cavities. They are then filled on a line also installed by SIPA.

SIPA provided important input in the development process for this very special container. In particular, as the preform was designed by a third party, it provided an analysis on optimum parameters for the reheat-stretch-blow molding sequence.

SIPA also collaborated on fine-tuning the design of the bottle. This was quite critical, since the volume of the container, when produced with a three-cavity mold - produced by SIPA of course - is close to the upper range limit for the blow molding machine in question. In addition, SIPA worked on making sure that the labels could be applied correctly onto the bottle - this in-



volved minor modifications to the panels of the bottle to provide a suitable surface.

Marko Tkachuk is the CEO of IDS Group Ukraine.

He said that the company has achieved success in difficult times, thanks to a concentration on sustainable development and emphasis on high quality production.

“Our objective is to strengthen our leadership in the mineral water market, because today, only the strongest can afford to invest in innovation and development,” he said. “We continue to work on strengthening customer loyalty to our brands.”

Marko Tkachuk said that while market trends continue to change, IDS Group Ukraine strives to stay one step ahead of the game, “to ensure that our customer always receives products that combine high quality, innovation and modern trends.” The special edition ball shaped bottle is a clear demonstration of the company’s ability to combine all key demands together successfully.

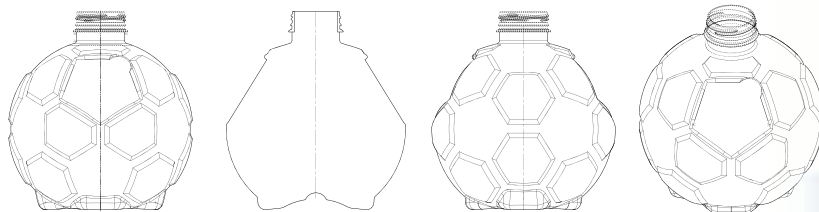
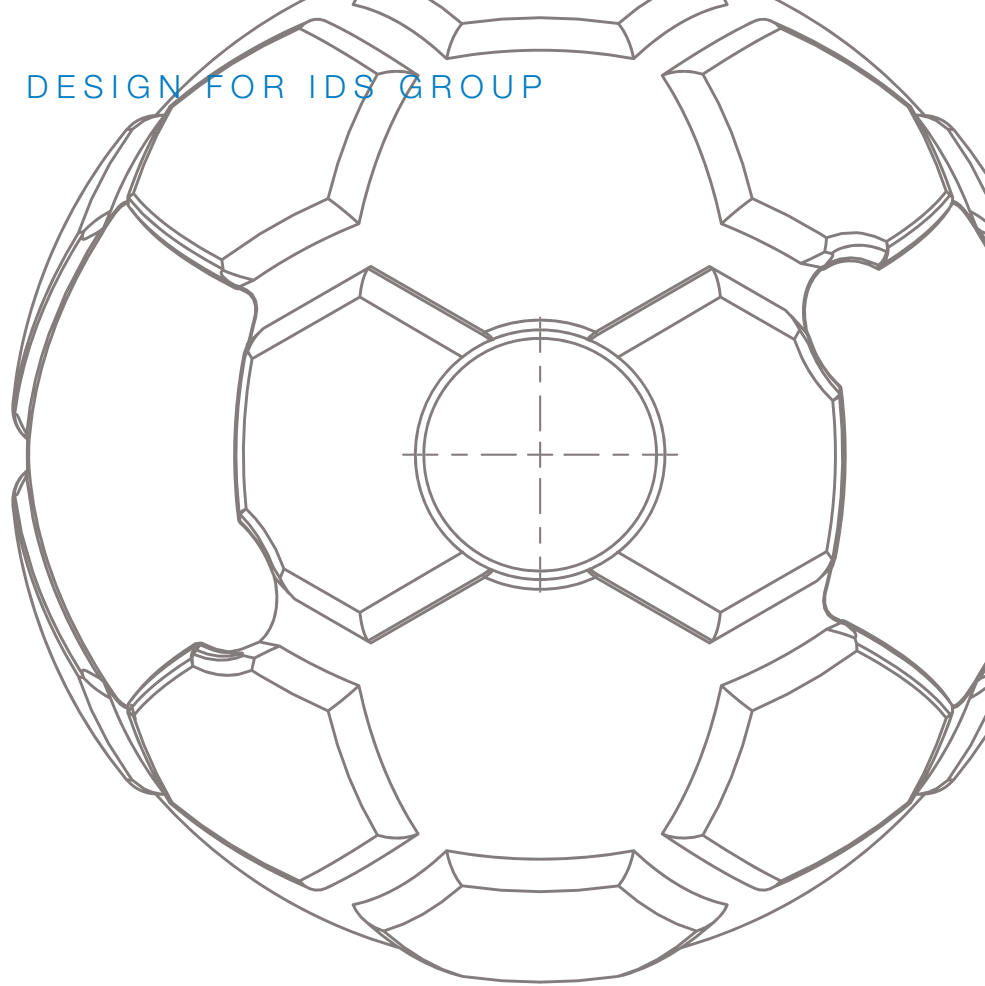

SIPA NOW MAKES CAPPELLO DESIGN



SIPA has signed an agreement with Concordia Development in Milan to use Concordia's Cappello preform base design in preform molds. This increasingly popular design, which is already being used by several major brands around the world, makes it possible to reduce the overall weight of a PET bottle by around 2%.

The Cappello base design is distinguished by a slightly more pointed profile than standard designs and its main interest lies in the material savings around the injection point, in an area where there is usually excess of amorphous material on a blown bottle. In other words, this leads to better optimized material distribution in the base of the finished bottle.

For most cases, and this has been demonstrated many times in indus-



trial conditions, there are no adjustments required on the blowing process side, or if any, only very minor ones essentially some fine-tuning to the reheating process - and no

changes at all to the stretch-blow molding hardware. Despite the profile design change, the preform tip has the required mechanical resistance to the stretch rod dur-

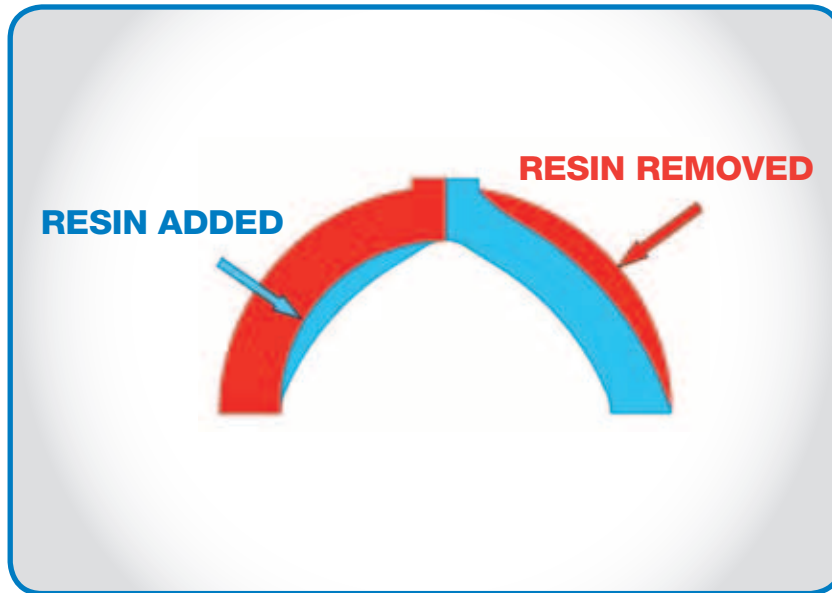

ing stretch-blow molding, and the finished bottle has mechanical properties undistinguishable from bottles made with standard preforms. For carbonated applications however, due to the fact that Cappello allows to remove the excess of amorphous material around the injection point, customers can expect even better bottle performances than with the corresponding standard base shape, especially for the stress cracking resistance. On the injection hardware side, knowing that the overall preform

length and wall thickness remain the same, the implementation of the Cappello design requires modification to the core, gate insert and cooling insert of the take out tube, nothing else. SIPA can modify molds that it has produced, and also, molds from third parties. Naturally, it can also incorporate the Cappello base design into new molds. Due to the material savings and because of the corresponding limited hardware changes on the injection mold, customers can expect very fast return on investment when

implementing Cappello, typically around 6 months, which makes Cappello a “no-brainer” option. The Cappello design has been proven to be suitable for carbonated applications from 0.33 liter to 3 liter, and for non-carbonated applications from 0.33 liter to 20 liter.

There are nowadays about 15 billion preforms produced per year worldwide with Cappello, which makes this design the most efficient and preferred base lightweighting solution on the market.



PROTOTYPE MOLDS HAVE
A CELL TO THEMSELVES

PETWORK - FAST PROTOTYPING

SIPA customers value the company's comprehensive prototype mold service. The company can provide trial cores, cavities and neck rings for new product development, with lead times normally of around a month. Now the service is even better than before. SIPA is cutting delivery times in half with the establishment of a production cell dedicated to proto-

types. In future, it should be possible for customers to take delivery of standard trial stack components in as little as two weeks. Preforms with standard neck finishes can be supplied in three to four weeks.

"By managing prototype requests separately and differently from full production orders, we are providing our customers will increased flexibil-

ity for their development projects," says Innovation Director, Laurent Sigler. "We can now be much more responsive to their requests."

Prototype components are made on exactly the same equipment and in the same materials as production tooling, so they are fully compatible.





Bottle samples from the prototyping is being extensively tested in order to make sure the customer is going to get the most optimized container.

A PREFORM INJECTION MOLD FROM SIPA IS A FRIEND FOR LIFE

“SIPA has probably the best solution on the market for producing PET preform molds with very highly wear-resistant surfaces.

“It is a solution that is robust and strong,” says Innovation Director, Laurent Sigler. Many customers have already embraced this solution and they are happy with it. “We think that mold longevity is a critical element of the tooling,” says Sigler.

“More and more customers are realising that tooling performance alone is not enough, mold life time is definitely a key element to

be considered in the purchasing phase”. “It’s just like when you buy a car. The performance of a car is not the only thing you look for. Having to do an oil change every 20,000 km instead of every 30,000 km may finally lead you to choose the second car”. Coming back to our mold, from an economical perspective, having a long lasting mold also makes a lot of sense.

To take an example, running a 30g preform at 10s or at 11s may appear drastically different if only cycle performance is compared.

For a 72 cavity mold, the differ-

ence in output on a yearly basis could be as high as 15 million preforms. But, on the entire mold life, let’s say over 10 million of cycles, comparing a mold running at 10s but requiring a complete cold half refurbishing after 5 to 6 million of cycles to a mold running at 11s but which would not require any cold half refurbishing before reaching the 10 million of cycles, the overall output per capital (of invested tooling capital) will end up to be much more favourable for the latter one, by about 10%, which is somehow significant.



Preforms produced on yearly basis

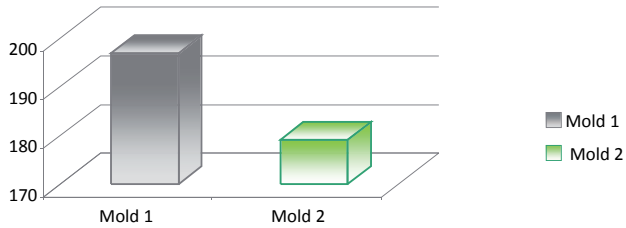

Number of production cycles per year

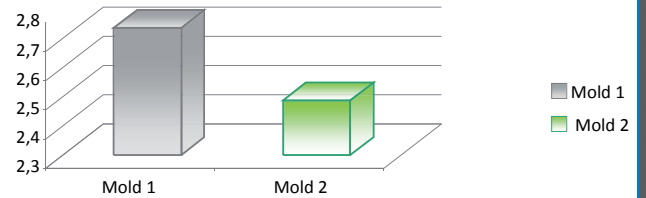

Preforms produced after 10 million production cycles

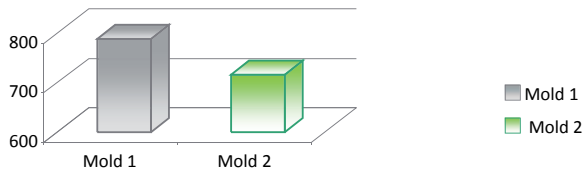

Total tooling costs over 10 million cycles

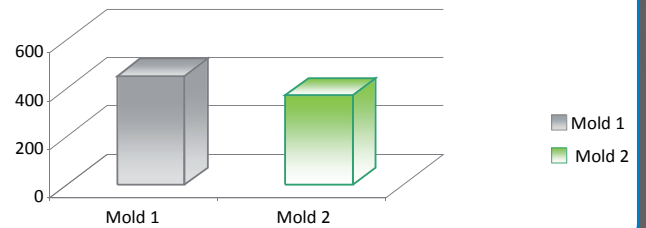

Output/Capital (of invested tooling capital)

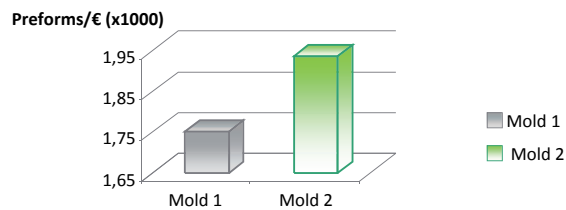

+ 10.6 % IN FAVOUR OF MOLD 2



Around 5,000 hectares are cultivated with vineyards, and includes 60 sparkling wine houses, about 3000 wine growers and 1500 operators in the wine business. This is where the exclusive Cartizze Prosecco, comes from: the local land morphology and micro-climate have conferred on this wine, grown over just 100 hectares, precious organoleptic qualities that are appreciated worldwide.

THE TRUE CHARM OF THE PROSECCO SUPERIORE DISTRICT

Just over an hour's drive from Venice, a group of hills encircles a natural amphitheatre lying between Conegliano and Valdobbiadene. Here, some 25 km from Treviso, in the north of Marca Trevigiana, as the province was once known, is where the famous Prosecco Superiore sparkling wine comes from.

In the near distance you can see the imposing Veneto Dolomites rising in the background. The visitor coming from the plain is greeted with lovely, unexpected scenery where steep inclines alternate with gentle slopes and there are endless rows of vineyards. In this beautiful area, everything seems to carry the scent of wine and hearty flavors, with century-old enological traditions that have deeply marked the landscape and its spirit. The people here love their roots and have retained a taste for

tradition and the pleasure of hospitality, along with that for local food products like cold meats and cheeses, chestnuts, grappa, mushrooms and honey. This is a district full of charm, of historical and artistic attractions, of precious, often unexpected and jealously guarded surprises. Castles, aristocratic villas, lone monuments, churches and hot springs dating back to Roman times all dot the landscape. Towns such as Conegliano, Vittorio Veneto, Valdobbia-

dene and Pieve di Soligo are full of natural and architectural treasures. All around, with age-old patience, the vines await to meet the sun and witness the solemn alternation of seasons, colors and tastes. The best way to get to know this district is to follow the Prosecco and Colli Conegliano Valdobbiadene Wine Road, Italy's oldest, which takes the visitor over three theme routes to discover historic-artistic sights as well as the most prestigious crus, or growths.



A NEW HOME FOR SIPA NORTH AMERICA

SIPA North America has just moved into bigger and better offices in Atlanta. They will allow it to significantly increase its ability to cater to the needs of its expanding customer base in the region.

The new location, covering 20,000 sq ft and just five minutes from Atlanta airport, now enables the company to provide more service support, with its extra room for warehousing as well as personnel.

From its new location, SIPA North America follows the entire North American market, providing:

- Sales and support with a team of sales area and key account managers;
- A spare parts warehouse with a 24/7 availability service;
- A highly skilled technical help desk;
- Process specialists and service engineers offering support for all daily customer requests;





- Local project management;
- Human resource, accounting and financial staff support.

The SIPA North America team now comprises over 30 full-time staff, supported by several outside contractors. It currently serves customers operating over 160 machines, and has the capability to supply more than 90% of required after-sales parts within 24 hours.

SIPA can now manage and deliver all parts faster and with less fuss.

Plus, it has the additional space it needs to install a machine showroom in the near future, and also intro-

duce a customer mold refurbishing service.

Marco Bottecchia, SIPA North America President says: “SIPA is built on innovation and close customer relationships.

Our technology base positions us to serve customers who seek differentiation through solutions that provide them with speed and flexibility in different market segments.

The new SIPA NA home will permit us to improve how we are following the company strategy in a key region.

Thanks to additional services, SIPA NA is targeting to increase the ex-

tension and quality level of our thorough local customer support from the first project discussion to the daily machine long life service support”.

SIPA NORTH AMERICA, INC.
4341 International Parkway
Suite 110
Atlanta, GA 30354
T: 404-349-3966
F: 404-574-5568

NEXT EVENTS 2012

1-5 APR.	NPE 2012 ORLANDO, USA	www.NPE.org
18-21 APR.	CHINAPLAS 2012 SHANGHAI, CHINA	www.chinaplasonline.com
23-26 APR.	DJAZAGRO 2012 ALGERS, ALGERIA	www.djazagro.com
8-12 MAY	PLAST 2012 MILANO, ITALY	www.plastonline.org
27-30 MAY	IRAN IRAN FOOD+BEVTEC 2012 TEHRAN, IRAN	www.iran-foodbevtec.com
12-15 JUNE	FISPAL TECNOLOGIA 2012 SAO PAULO, BRAZIL	www.fispaltecnologia.com.br
19-22 SEPT.	CHINA BREW & CHINA BEVERAGE 2012 BEIJING, CHINA	www.chinabrew-beverage.com
16-20 OCT.	FAKUMA 2012 FRIEDRICHSHAFEN, GERMANY	www.fakuma-messe.de/en/fakuma
28-31 OCT.	PACK EXPO 2012 CHICAGO, USA	www.packexpo.com
13-15 NOV.	BRAU BEVIALE 2012 NURNBERG, GERMANY	www.brau-beviale.de/en/
19-22 NOV.	EMBALLAGE 2012 PARIS, FRANCE	www.emballageweb.com

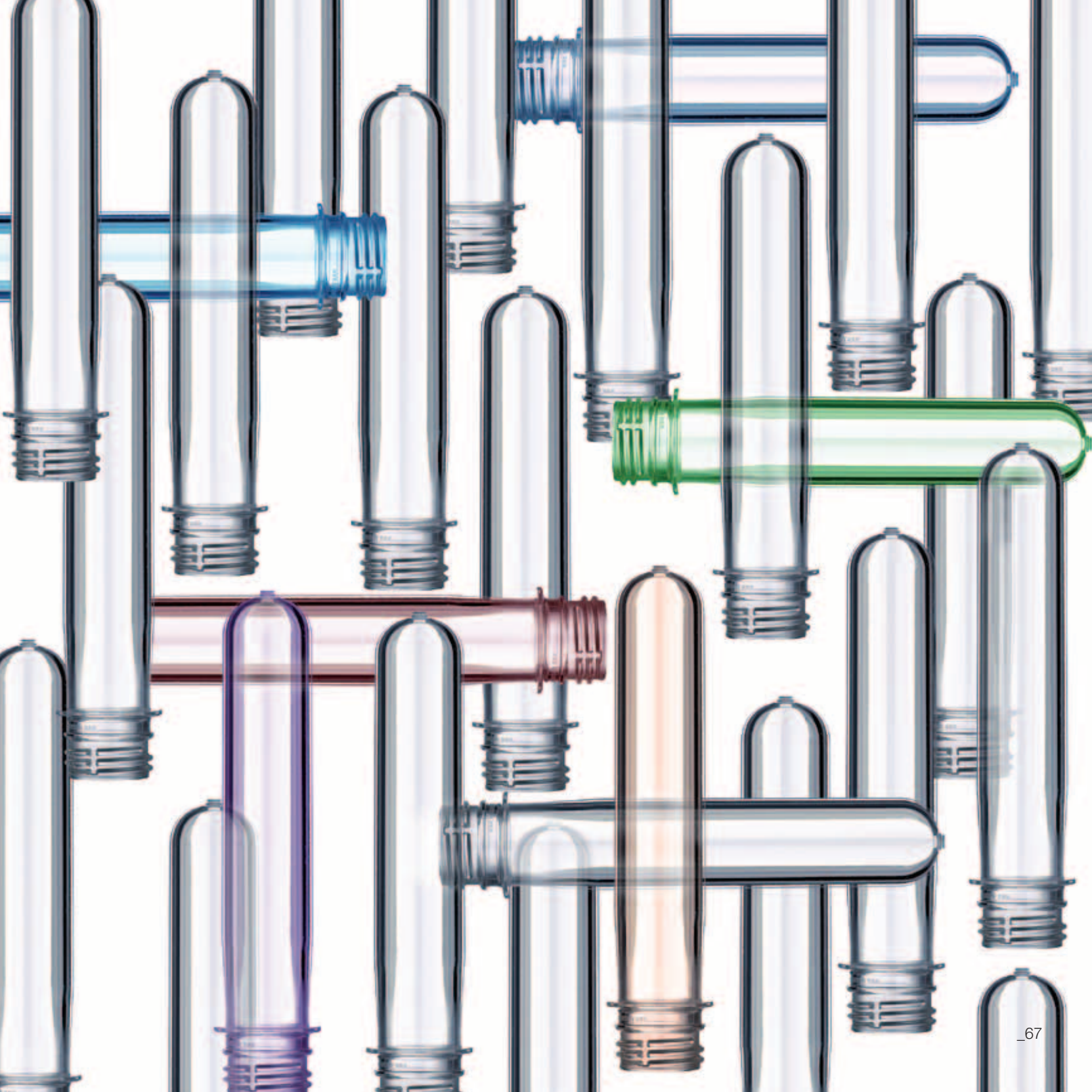

Zoppas Industries



SIPA S.p.A. - via Caduti del Lavoro, 3 - 31029 Vittorio Veneto (ITALY)
Tel. +39 0438 911 511 - Fax: +39 0348 912 273 - sipa@zoppas.com - www.sipa.it